

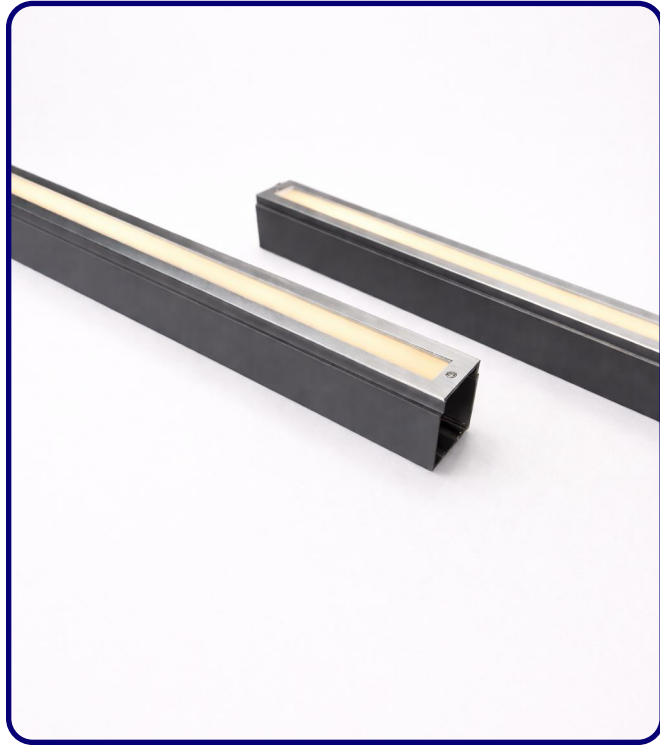

FIXTURE TYPE: _____

PROJECT NAME: _____



GENERAL INFORMATION:

Lumina Collection offers sophisticated inground lights in two models and sizes, catering to diverse outdoor lighting needs. Choose from 14.4W or 28.8W power options to suit your project requirements. With reliable performance and durable construction rated IK07, Lumina enhances your landscape with elegance and functionality.

FIXTURE TYPE:

Inground Luminaire - Linear Luminaires

LIGHTING:

LED

LED

VOLTAGE:

110-277V

110-277V

MATERIAL:

Extruded aluminium, powder coated

CRI:

80

IP RATING:

IP 67

IP67

IK RATING:

IK 07

sales@gordonbullard.com
www.bullardoutdoor.com
1-877-964-4646



991 South Gull Lake Dr
Richland, MI 49083
USA

FIXTURE TYPE: _____

PROJECT NAME: _____

NOTES:

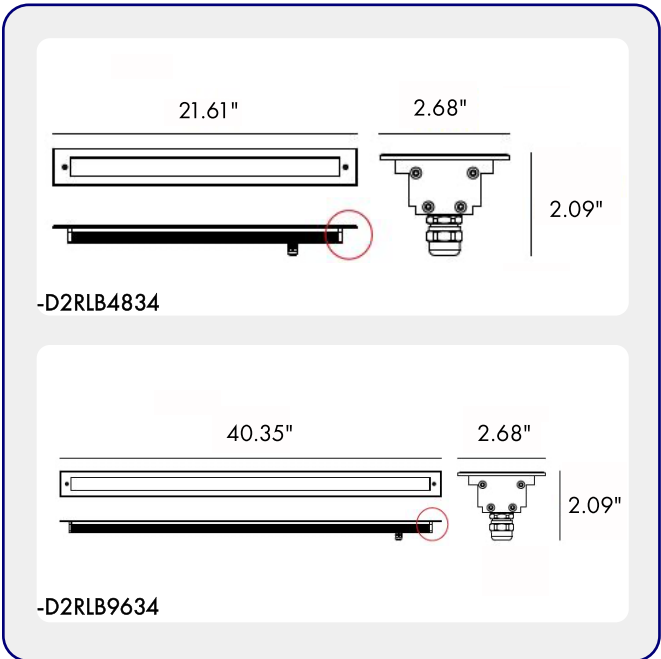

HOW TO ORDER:

CODE:

Example:
CODE: BO-LU-KPG-IL-XXX-XXX-XXX-XXX-XXX-XXX

BO-LU-KPG-IL-D2RLB4834-K30-B-

1 MODELS:

CODE -D2RLB4834

DIMENSIONS:

Height - H: 2.09" (5.3 cm)
Width - W: 2.68" (6.8 cm)
Length - L: 21.61" (54.9 cm)

LIGHT SOURCE:

LED / 48 x 0.3W / 555 mA / 300 lm / IK 07 / 110-277V

CODE -D2RLB9634

DIMENSIONS:

Height - H: 2.09" (5.3 cm)
Width - W: 2.68" (6.8 cm)
Length - L: 40.35" (102.5 cm)

LIGHT SOURCE:

LED / 96 x 0.3W / 1108 mA / 602 lm / IK 07 / 110-277V

2 CCT OPTIONS:

-K30 3000K
-CUS Custom on request*

3 WATER PROOF SOLUTION: (optional)

- B **A Water-Stopper(Included)**
IP-67 water-stopper is added in the end of luminaires as standard assembly which is also an important system for water resistance.
- B IP67 Jiffy quick plug/socket connector(Optional)**
IP-67 connector is as an Optional assembly and ensures that water vapor will not enter into luminaires directly.



sales@gordonbullard.com
www.bullardoutdoor.com
1-877-964-4646



991 South Gull Lake Dr
Richland, MI 49083
USA

FIXTURE TYPE: _____

PROJECT NAME: _____

NOTES:



HOW TO ORDER:

CODE:

Example:
CODE: BO-LU-KPG-IL-XXX-XXX-XXX-XXX-XXX-XXX

BO-LU-KPG-IL-D2RLB4834-K30-B-

4 ACCESSORIES:

SLEEVE (INCLUDED)

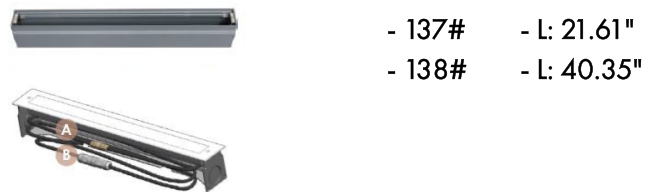

5 PHOTOMETRIC INFO:

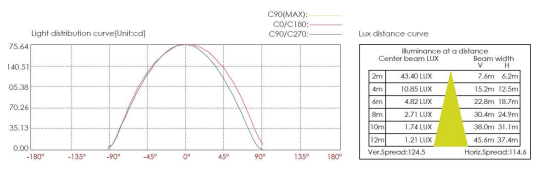
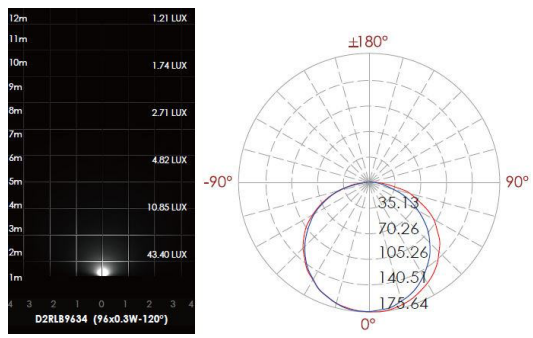
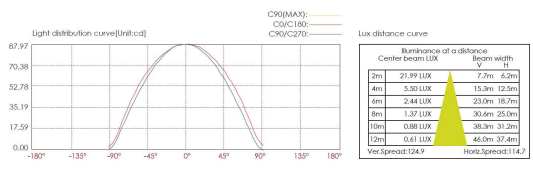
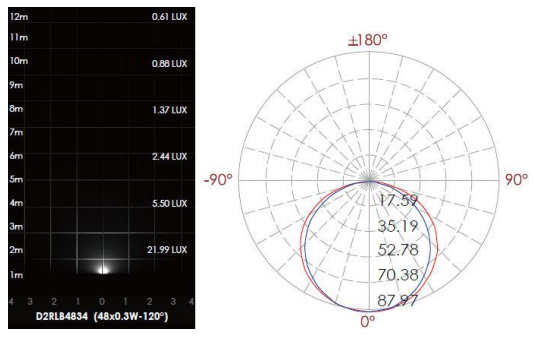

sales@gordonbullard.com
www.bullardoutdoor.com
1-877-964-4646



991 South Gull Lake Dr
Richland, MI 49083
USA