



FIXTURE TYPE: _____

PROJECT NAME: _____

NOTES:



GENERAL INFORMATION:

Break Line is a luminous bar counter, which belongs family display. Break Line is a luminous bar counter, minimal and versatile, which lights up indoors and outdoors, small areas and huge gardens. Break Line could have a top in tempered glass. Resistant and easy to clean, Break Line is an ideal solution for contract and events. It is possible to complete Break Line with some accessories, as a speed rack and a cocktail station. The luminous bar counter Break Line is made in polyethylene with the technology of rotational moulding. It is available only in lighting white and it is possible to customize it with logos or images.

FIXTURE TYPE:

Illuminated Furniture

VOLTAGE:

110-277V

MATERIAL:

Polyethylene

IP RATING:

IP 55

IP 55

FINISH OPTION:

Light white

WARRANTY:

Lighting products are warranted for 5 years.

APPLIANCE CLASS:

II



FIXTURE TYPE: _____

PROJECT NAME: _____

NOTES:

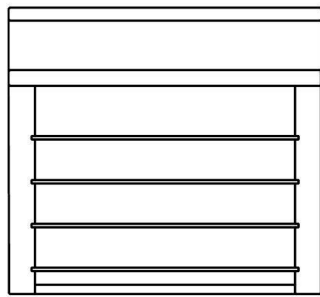

47.24"
[120 cm]
A)

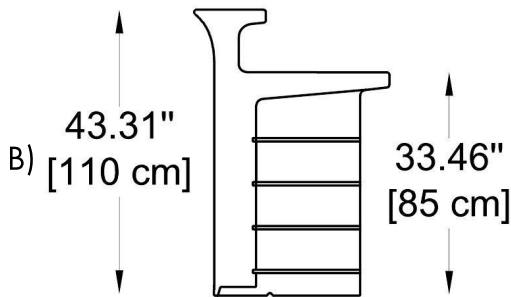

B) 43.31"
[110 cm]

33.46"
[85 cm]

C) 29.53"
[75 cm]

E26

IP 55



HOW TO ORDER:

CODE:

Example:
CODE: BO-LPBRD-SD-116-117-111-112

BO-LPBRD-
SD-116-117-111-
112

1 DIMENSIONS:

A) Length - L: 47,24" (120 cm)
B) Height - H: 43,31" (110 cm)
C) Width - W: 29,53" (75 cm)

2 LIGHT SOURCE:

E26 / 2 x max. 10W / 110-277V

3 FINISH OPTION:

Light white

4 WIRING:

Black cable (Length 10 ft.)

5 WEIGHT:

88, 18 lb

6 ACCESSORIES: (not-included)

DESKS:

-116 Satinated glass
-114 Steel silver

TOPS:

-117 Satinated glass
-115 Steel silver

Satinated glass Steel silver

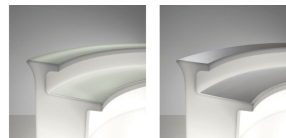

SHELF:

-111 Tempered glass (max. 4 shelves per counter)

sales@gordonbullard.com

www.bullardoutdoor.com

1-877-964-4646



991 South Gull Lake Dr

Richland, MI 49083

USA

FIXTURE TYPE: _____

PROJECT NAME: _____

NOTES:

HOW TO ORDER:

CODE:

Example:
CODE: BO-LPBRD-SD-116-117-111-112

BO-LPBRD-
SD-116-117-111-
112

6 ACCESSORIES: (not-included)

CODE: -112
COCKTAIL STATION
Material - ABS
Dimensions:
L: 21.46" (54,5 cm)
H: 14.57" (37 cm)
W: 33.07" (84 cm)
Finish options - Black

CODE: -113
SPEED RACK
Material - ABS
Dimensions:
L: 3.94" (10 cm)
H: 8.07" (20,5 cm)
W: 33.07" (84 cm)
Finish options - Black

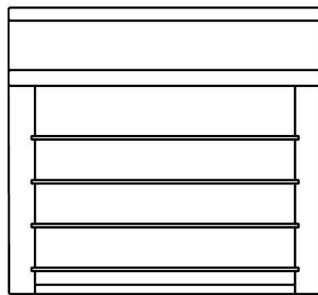
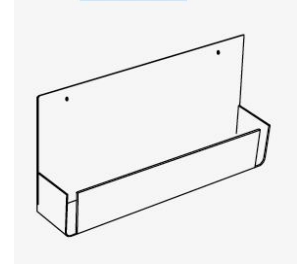
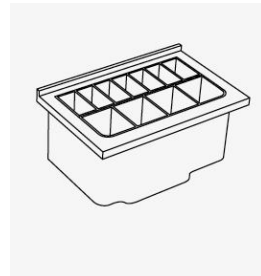

47.24"
[120 cm]
A)

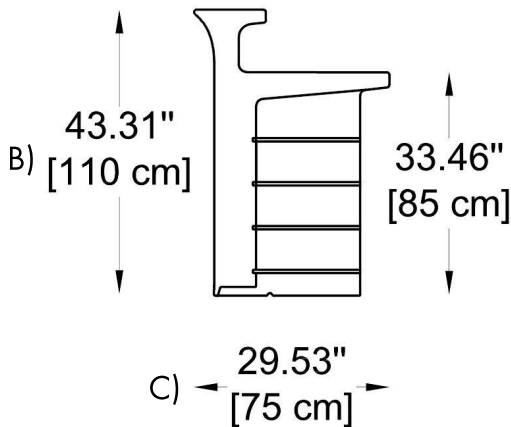

sales@gordonbullard.com
www.bullardoutdoor.com
1-877-964-4646



991 South Gull Lake Dr
Richland, MI 49083
USA