

ARGUS



Data Sheet:

Input Voltage (V): 110-277
 IK 06

Installation steps

Step 1

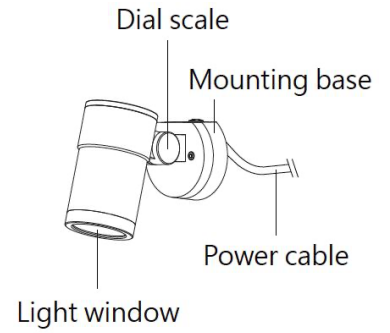
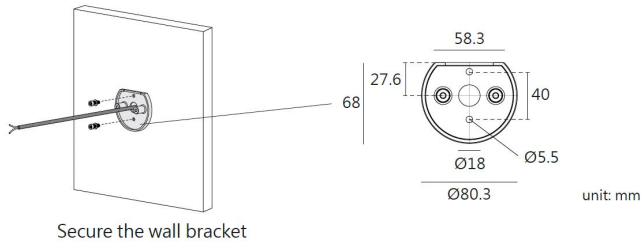

Bevel cut hood & Honeycomb louver

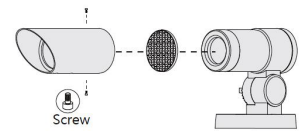

Step 2

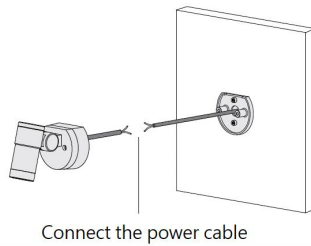

Step 3

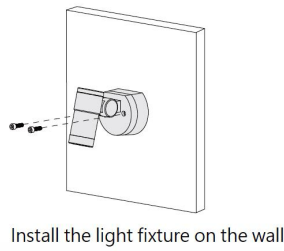

4.2 Tree pole strap

Step 1

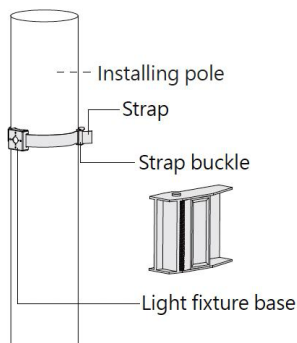

Step 2

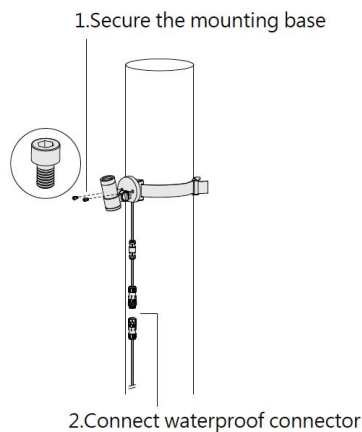

Step 3

