



FIXTURE TYPE: \_\_\_\_\_

PROJECT NAME: \_\_\_\_\_



**GENERAL INFORMATION:**

Beamz is LED inground light, available in square and round forms, offers stylish illumination. Crafted from durable die-casting aluminum with sleek black finish options, Beamz ensures durability and aesthetic appeal. With a focused 24° beam angle and R8 reflector, it provides uniform lighting. Supporting dimming, it offers brightness control. With an IK rating of 06, Beamz guarantees durability in various settings.

**FIXTURE TYPE:**

Inground Luminaire - Compact/Mini

**LIGHTING:**

LED

LED

**VOLTAGE:**

110-277V



**MATERIAL:**

12# Die-casting aluminium powder coated

**CRI:**

80

**IP RATING:**

IP 67

IP67

**IK RATING:**

IK 06

sales@gordonbullard.com  
www.bullardoutdoor.com  
1-877-964-4646



991 South Gull Lake Dr  
Richland, MI 49083  
USA

FIXTURE TYPE: \_\_\_\_\_

PROJECT NAME: \_\_\_\_\_

NOTES:

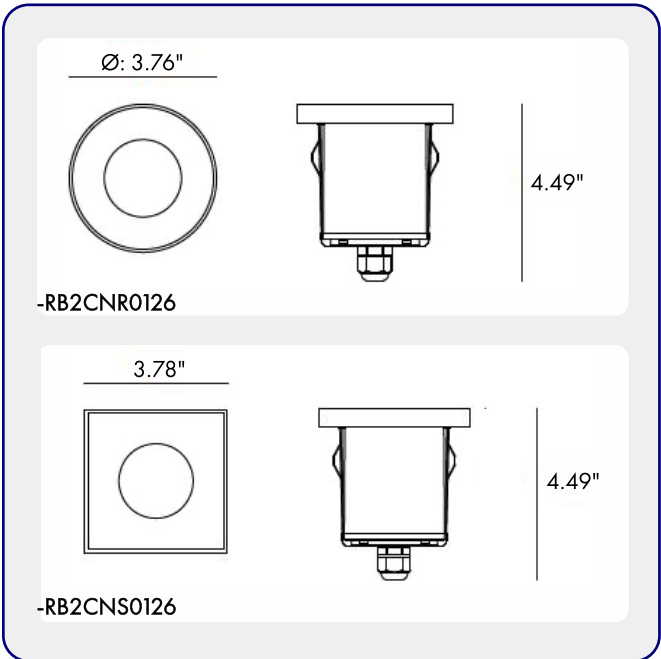

**HOW TO ORDER:**

**CODE:**

Example:  
CODE: BO-BZ-KPG-IL-XXX-XXX-XXX-XXX-XXX-XXX

BO-BZ-KPG-IL-RB2CNR0126-K30-B-R8-15-B05-

**1 MODELS:**

CODE -RB2CNR0126

DIMENSIONS:

Diameter - Ø: 3.76" (9.5 cm)  
Height - H: 4.49" (11.4 cm)

LIGHT SOURCE:

LED / 1 x 6W / 320 mA / 909 lm / IK 06 / 110-277V

CODE -RB2CNS0126

DIMENSIONS:

Width - W: 3.78" (9.6 cm)  
Height - H: 4.49" (11.4 cm)

LIGHT SOURCE:

LED / 1 x 6W / 320 mA / 909 lm / IK 06 / 110-277V

**2 CCT OPTIONS:**

-K30 3000K  
-CUS Custom on request\*

**3 WATER PROOF SOLUTION: (optional)**

-B **A Water-Stopper(Included)**  
IP-67 water-stopper is added in the end of luminaires as standard assembly which is also an important system for water resistance.



**4 OPTICS:**

-R8-15 15°  
-R8-24 24°  
-R8-38 38°  
-R8-60 60°

sales@gordonbullard.com  
www.bullardoutdoor.com  
1-877-964-4646



991 South Gull Lake Dr  
Richland, MI 49083  
USA

FIXTURE TYPE: \_\_\_\_\_

PROJECT NAME: \_\_\_\_\_

NOTES:



**HOW TO ORDER:**

**CODE:**

Example:  
CODE: BO-BZ-KPG-IL-XXX-XXX-XXX-XXX-XXX-XXX

BO-BZ-KPG-IL-RB2CNR0126-K30-B-R8-15-B05-

**5 ACCESSORIES:**

**SLEEVE (OPTION 1)**

**SLEEVE (OPTION 2)**

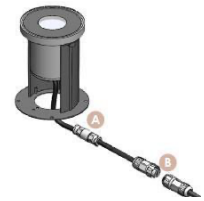
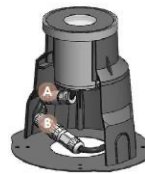

- B05 - RB2CNR0126
- B06 - RB2CNS0126

- 085# - RB2CNR0126
- 086# - RB2CNS0126

**6 PHOTOMETRIC INFO:**

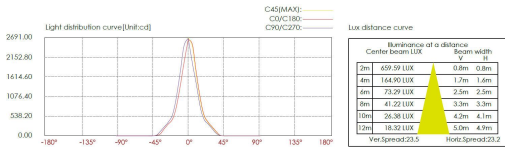
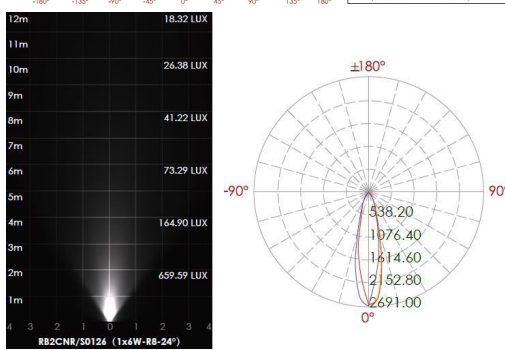
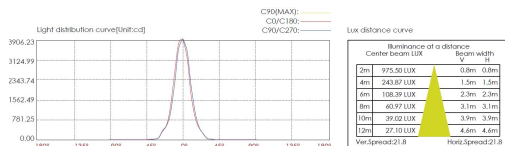
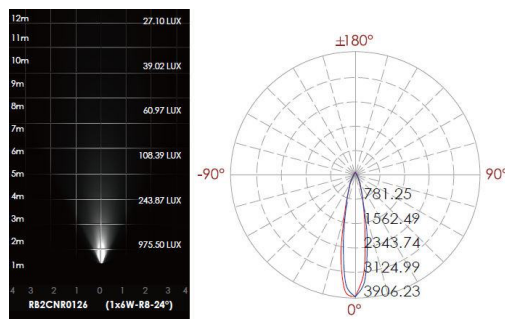

sales@gordonbullard.com  
www.bullardoutdoor.com  
1-877-964-4646



991 South Gull Lake Dr  
Richland, MI 49083  
USA