



**BULLARD**  
**OUTDOOR**  
BUILT for the STORM

# INSTALLATION INSTRUCTION

01/28/2026

# RAYZ



## Exterior details

### Luminaire

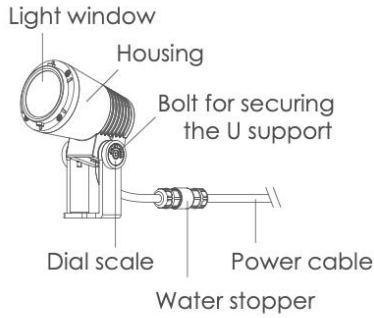

### Optional accessories

#### Spike

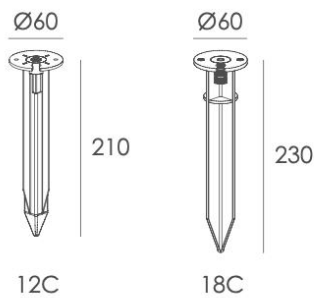

#### Spike

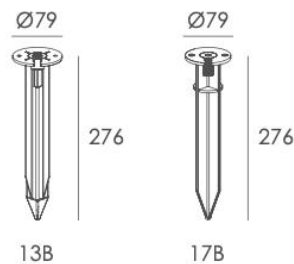

#### Bevel cut hood



#### Honeycomb Louver

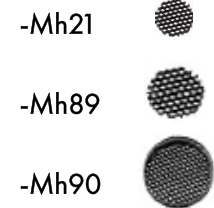

#### Round Surface Mounting Base



## Data Sheet:

Input Voltage (V): 110-277  
IK: 05

P.2

[sales@gordonbullard.com](mailto:sales@gordonbullard.com)  
[www.bullardoutdoor.com](http://www.bullardoutdoor.com)  
1 877-964-4646



991 South Gull Lake Dr.  
Richland, MI 49083  
USA



## Installation steps

### Step 1

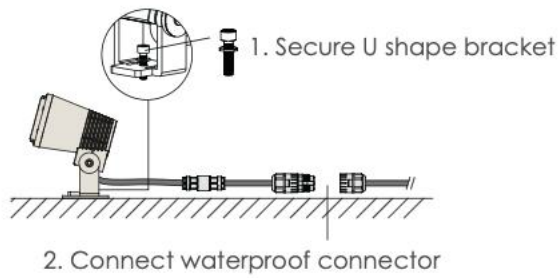

### Step 2

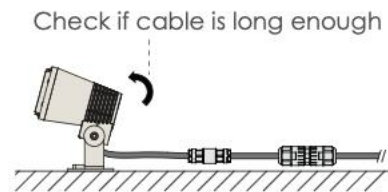

## Accessories assemble - Spike

### Step 1

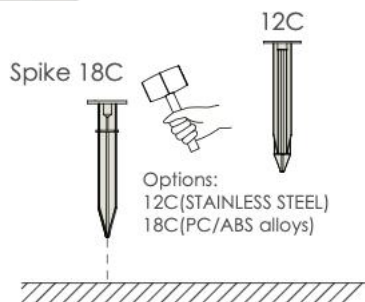

### Step 2

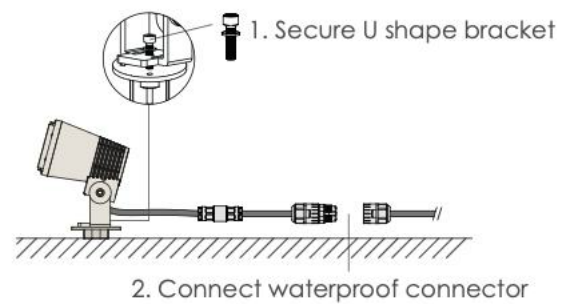

### Step 3

