



FIXTURE TYPE: \_\_\_\_\_

PROJECT NAME: \_\_\_\_\_



**GENERAL INFORMATION:**

Norie Collection offers sophisticated inground lights in three models and sizes, catering to diverse outdoor lighting needs. Featuring precision B15 lenses and efficient LED light sources, Norie delivers focused illumination with a 15° selected degree. With reliable performance and durable construction rated IK09, Norie enhances your landscape with elegance and functionality.

**FIXTURE TYPE:**

Inground Luminaire - Linear Luminaires

**LIGHTING:**

LED



**VOLTAGE:**

110-277V



**MATERIAL:**

Extruded aluminium, powder coated

**CRI:**

80

**IP RATING:**

IP 67



**IK RATING:**

IK 09

sales@gordonbullard.com  
www.bullardoutdoor.com  
1-877-964-4646



991 South Gull Lake Dr  
Richland, MI 49083  
USA

FIXTURE TYPE: \_\_\_\_\_

PROJECT NAME: \_\_\_\_\_

NOTES:

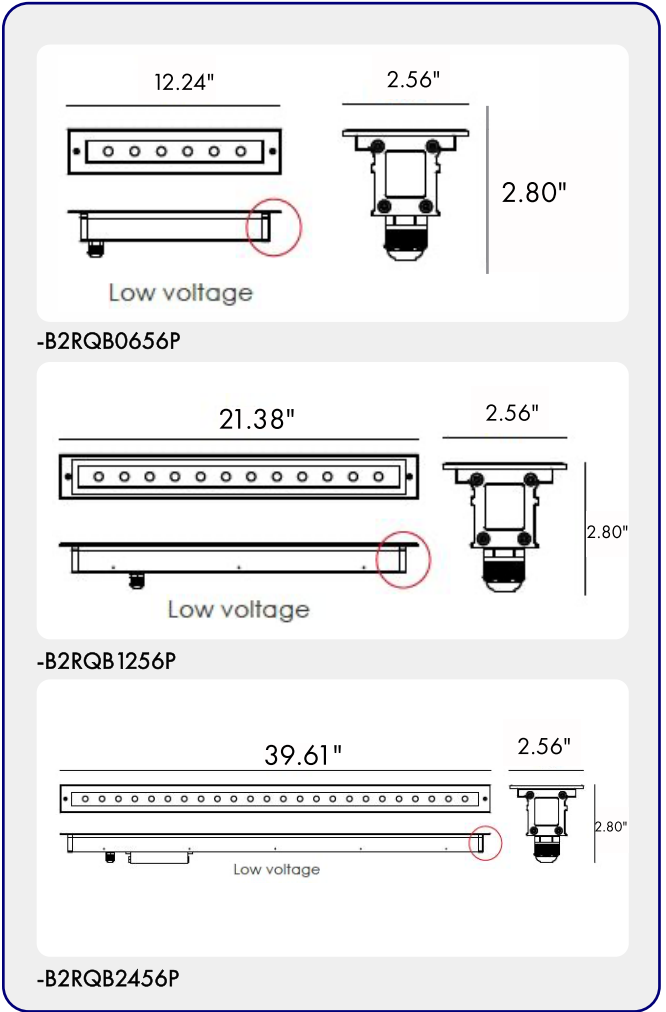

**HOW TO ORDER:** \_\_\_\_\_ **CODE:** \_\_\_\_\_

Example:  
CODE: BO-NE-KPG-IL-XXX-XXX-XXX-XXX-XXX-XXX

BO-NE-KPG-IL-  
B2RQB0656P-K30-B-

**1 MODELS:**

**CODE -B2RQB0656P**

DIMENSIONS:

Height - H: 2.80" (7.1 cm)  
Width - W: 2.56" (6.5 cm)  
Length - L: 12.24" (31.1 cm)

LIGHT SOURCE:

LED / 6 x 1.2W / 400 mA / 770 lm / IK 09 / 110-277V

**CODE -B2RQB1256P**

DIMENSIONS:

Height - H: 2.80" (7.1 cm)  
Width - W: 2.56" (6.5 cm)  
Length - L: 21.38" (54.3 cm)

LIGHT SOURCE:

LED / 12 x 1.2W / 800 mA / 1515 lm / IK 09 / 110-277V

**CODE -B2RQB2456P**

DIMENSIONS:

Height - H: 2.80" (7.1 cm)  
Width - W: 2.56" (6.5 cm)  
Length - L: 39.61" (100.6 cm)

LIGHT SOURCE:

LED / 24 x 1.2W / 1600 mA / 2968 lm / IK 09 / 110-277V

**2 CCT OPTIONS:**

-K30 3000K  
-CUS Custom on request\*

**3 OPTICS:**

-B15-10 10°  
-B15-15 15°  
-B15-20 20°  
-B15-30 30°

sales@gordonbullard.com  
www.bullardoutdoor.com  
1-877-964-4646



991 South Gull Lake Dr  
Richland, MI 49083  
USA

FIXTURE TYPE: \_\_\_\_\_

PROJECT NAME: \_\_\_\_\_

NOTES:



**HOW TO ORDER:**

**CODE:**

Example:  
CODE: BO-NE-KPG-IL-XXX-XXX-XXX-XXX-XXX-XXX

BO-NE-KPG-IL-  
B2RQB0656P-K30-B-



**4 WATER PROOF SOLUTION: (optional)**

- B **A Water-Stopper(Included)**  
IP-67 water-stopper is added in the end of luminaires as standard assembly which is also an important system for water resistance.
- B IP67 Jiffy quick plug/socket connector(Optional)**  
IP-67 connector is as an Optional assembly and ensures that water vapor will not enter into luminaires directly.



**5 ACCESSORIES:**

**SLEEVE (INCLUDED)**

-  - 145# - L: 12.24"
-  - 146# - L: 21.38"
-  - 147# - L: 39.61"

**6 PHOTOMETRIC INFO:**

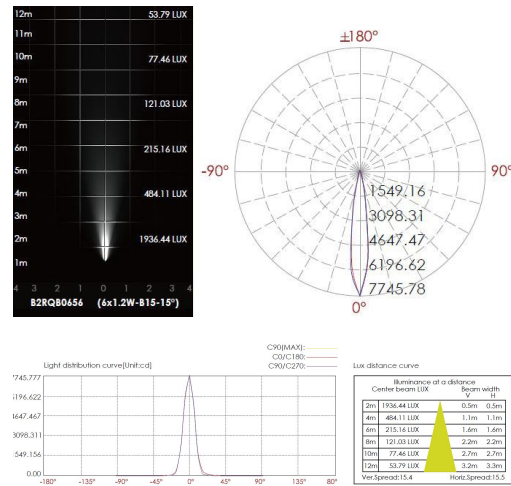

sales@gordonbullard.com  
www.bullardoutdoor.com  
1-877-964-4646



991 South Gull Lake Dr  
Richland, MI 49083  
USA

FIXTURE TYPE: \_\_\_\_\_

PROJECT NAME: \_\_\_\_\_

NOTES:



**HOW TO ORDER: \_\_\_\_\_ CODE: \_\_\_\_\_**

Example:  
CODE: BO-NE-KPG-IL-XXX-XXX-XXX-XXX-XXX-XXX

BO-NE-KPG-IL-  
B2RQB0656P-K30-B-

**6 PHOTOMETRIC INFO:**

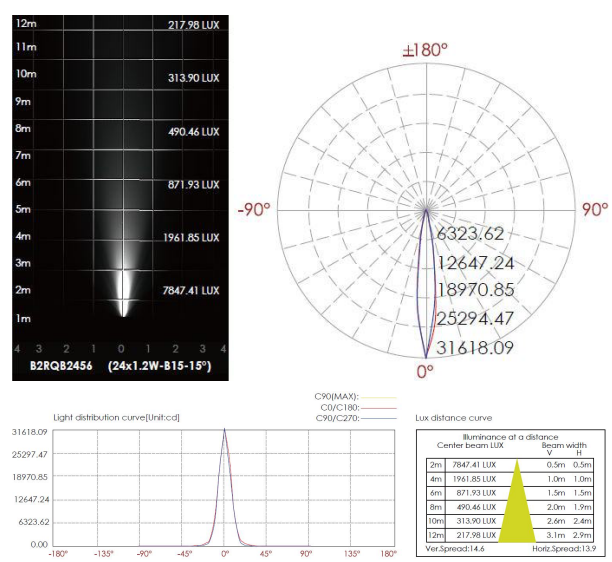
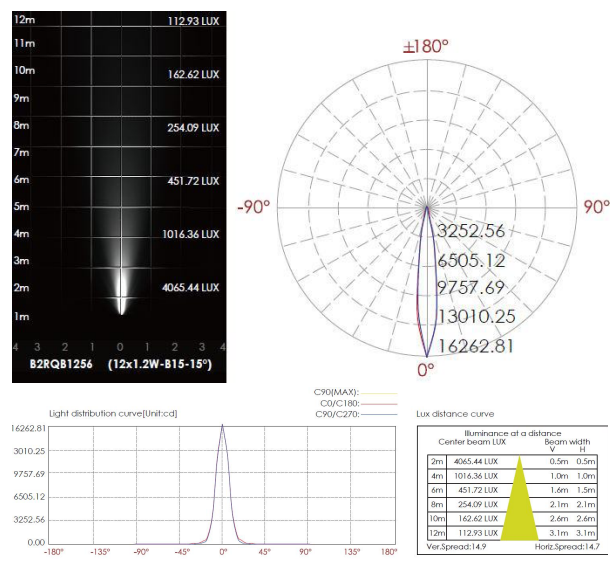

sales@gordonbullard.com  
www.bullardoutdoor.com  
1-877-964-4646



991 South Gull Lake Dr  
Richland, MI 49083  
USA